

# GPS 70 & GPS 120 in detail



# GPS 70 & GPS 120

Die-cast aluminium & steel pallets with standardised hole pattern. Minimum height in automation magazines by clamping without drawbar.



Pallet handling contour for automated pallet change by robot.



The Z-references are air blast cleaned, through nozzles in the Z-references of the chuck.

Spring loaded clamping mechanism. Releasing by air.



GPS 120 ring with references.

GPS 70 ring with references.



Hardened chuck body with prisms for X/Y centring made out of one piece for maximum stability. Indexing 4x90°.

Sealing rings for completely sealed chuck-pallet interface against dirt and swarf.

## GPS 70 & GPS 120

The machining zero point is defined by the centre of the chuck in the GPS 70 and GPS 120 system. The chucks can be mounted on the machine table of any machine tool. The standardised hole pattern of the pallet allows the fixation of workpieces, fixtures and accessories such as vices and three-jaw chucks from below. This gives collision-free mounting, even with five-sided machining.

The economical, pressure-die-cast aluminium pallets are very light, making them also suitable for manual handling. Naturally GPS 70 and GPS 120 are also suitable for automatic changing.

The chuck seal prevents dirt penetrating between the chuck and the pallet. This simplifies maintenance and lengthens the life of the components.

- Repetition accuracy: within 0.002 mm
- Indexing accuracy: within 0.005 mm
- Locking force: 3.000-3.800 N
- Fixed index positions 4x90°
- Required air pressure, pneumatic chuck: 6 bars ( $\pm 1$ )
- Recommended max workpiece weight GPS 70: 10 kg
- Recommended max workpiece weight GPS 120: 20 kg.

### ADVANTAGES



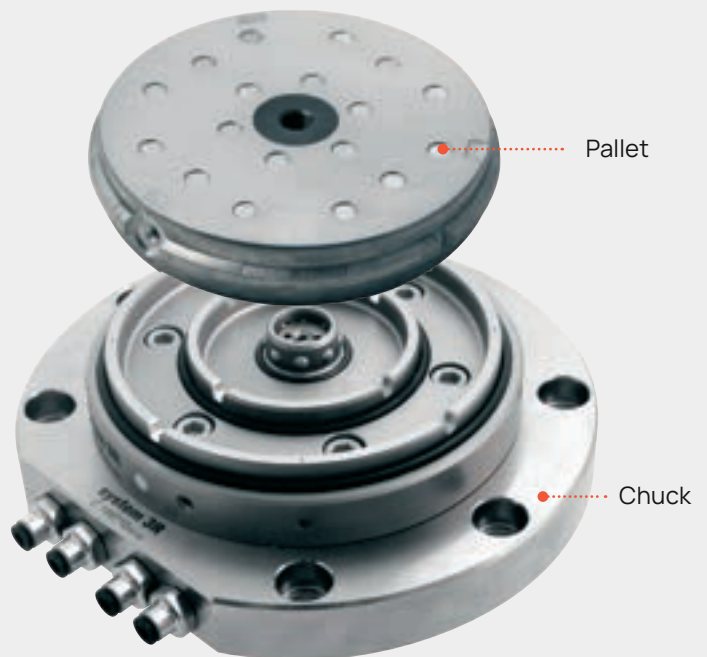

- reduces setting-up times.
- ensures precision and quality.
- is sealed against dirt and swarf.
- has pallet clamping without drawbar.
- has lightweight pallets.
- suitable for automatic changing with System 3R's automation program.

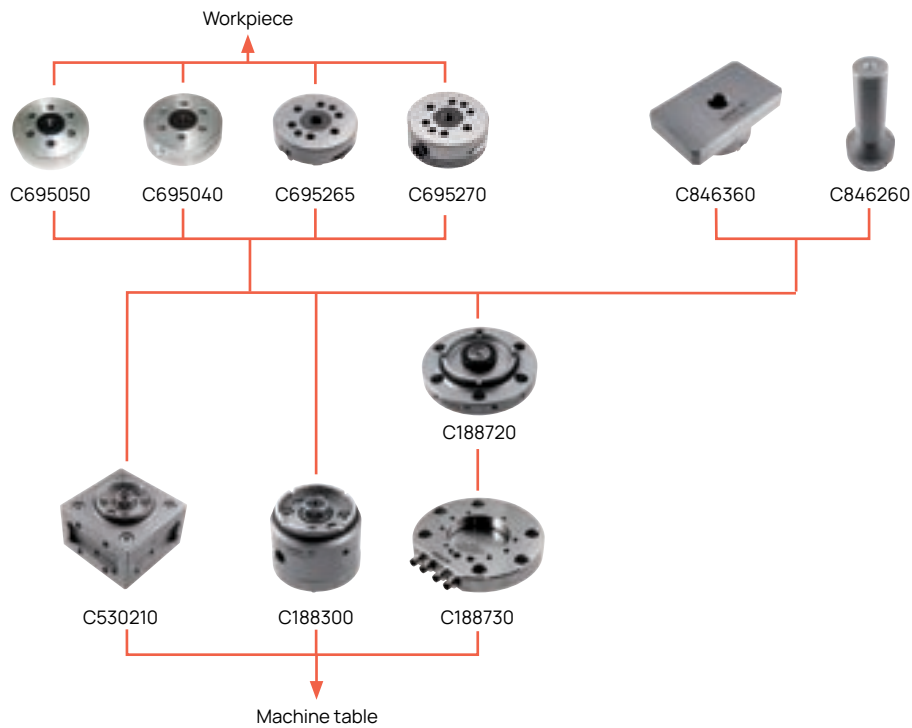



# GPS 70 – Chucks & pallets



Chucks	Article number	Feature
Manual, cube	C530210	
Manual, round	C188300	
Pneumatic automatic/manual	C188720	for manual machining operations
Flange	C188730	fits on C188720 & C188700

Pallets	Article number	Feature
Cast aluminium 	C695050	
Cast aluminium 	C695040	
Steel 	C695265	
Steel 	C695270	with pallet protection ring
Pallet protection ring	C695295	fits on C695265

 Pallet with coined cams     Pallet with spring hardened cams

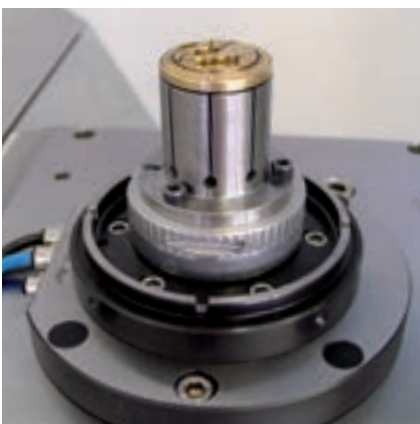

## GPS 70 – Chucks

### GPS 70 Machining cube, manual, C530210

For milling, grinding, die-sinking EDM, presetting and measuring station. Suitable for the 5-sided machining of electrodes and workpieces. One side is ground square with the base surface.

- Mounting (from the top) 70 x 70 mm, 4x M8 screws through holes (horizontal)
- Mounting (from the bottom) on GPS 240 pallet: 80 x 80 mm, 4x M8 screws threaded holes (horizontal), 40 x 40 mm, 4x M8 screws threaded holes (vertical)
- Releasing manual with Allen wrench.

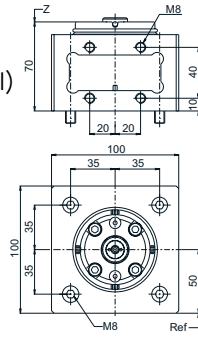
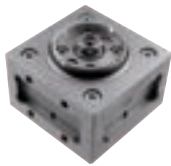

### GPS 70 Chuck, manual, C188300

For turning, milling, grinding, die-sinking EDM.

- Mounting 4x M6 screws
- Releasing manual with Allen wrench
- Flushing lateral inlet.

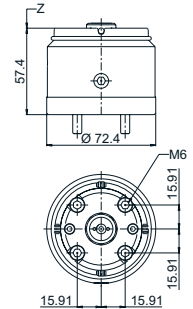

### GPS 70 Chuck, pneumatic, C188720

For milling, turning, grinding and die-sinking EDM.

- Mounting 6x M6 screws (fits on flange C188730)
- Releasing pneumatic, 6 bar
- Required air pressure 6 bars ( $\pm 1$ )
- Air-blast cleaning of Z-references.

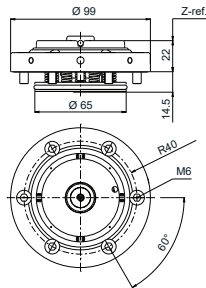

### Flange for GPS 70 chuck, C188730

Fits on C188720 and C198700.

- Material: stainless steel, heat pre-treated
- Mounting 6x M8
- Connections:
  - A = releasing/clamping
  - B = Air-blast cleaning of Z-references
  - C = drain/pallet room venting
  - D = piston room venting.

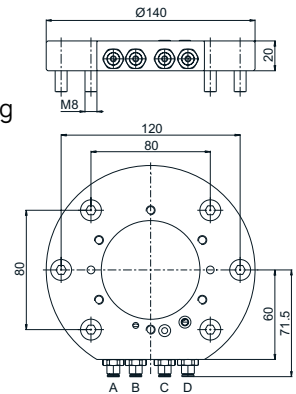

## GPS 70 – Pallets

### GPS 70 Aluminium pallet, C695050

Cast aluminium pallet.

- Construction height  $16.7 \pm 0.01$  mm
- X/Y-centring with coined cam
- Not prepared for automation.
- Weight 0.2 kg.

### Set of pallets, S500010

- C695050 supplied in sets of 9.

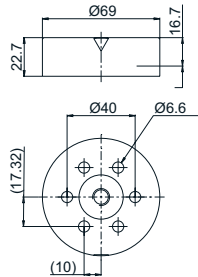

### GPS 70 Aluminium pallet, C695040

Cast aluminium pallet.

- Construction height  $16.7 \pm 0.01$  mm
- X/Y-centring with coined cam
- Ready for code carrier fixture C960740
- Prepared for automation.
- Weight 0.2 kg.

### Set of pallets, S500011

- C695040 supplied in sets of 9.

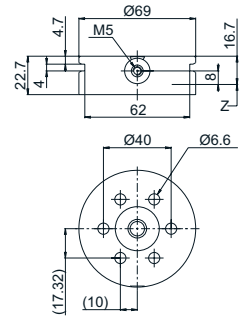

### GPS 70 Steel pallet, C695265

Workpiece and device holder for precision production.

- Construction height  $22 \pm 0.005$  mm
- X/Y-centring with springy cams, hardened, stainless
- Ready for code carrier fixture C960740
- Prepared for automation.
- Weight 0.5 kg.

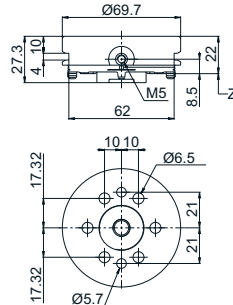

### GPS 70 Steel pallet, C695270

Workpiece and device holder for precision production with pallet protection ring aluminium.

- Construction height  $22 \pm 0.005$  mm
- X/Y-centring with springy cams, hardened, stainless
- Ready for code carrier 3R-863.01
- Prepared for automation.
- Weight 0.5 kg.

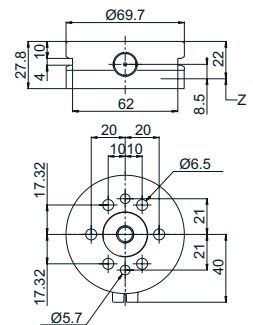

### GPS 70 Pallet protection ring, C695295

Chip protection between pallet and chuck for GPS 70 steel pallets C695265.

- Material plastic
- Dimensions  $\text{Ø}69.4 \times 10.8$  mm
- Use with code carrier.

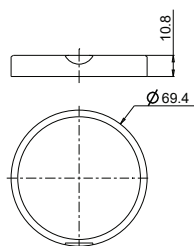



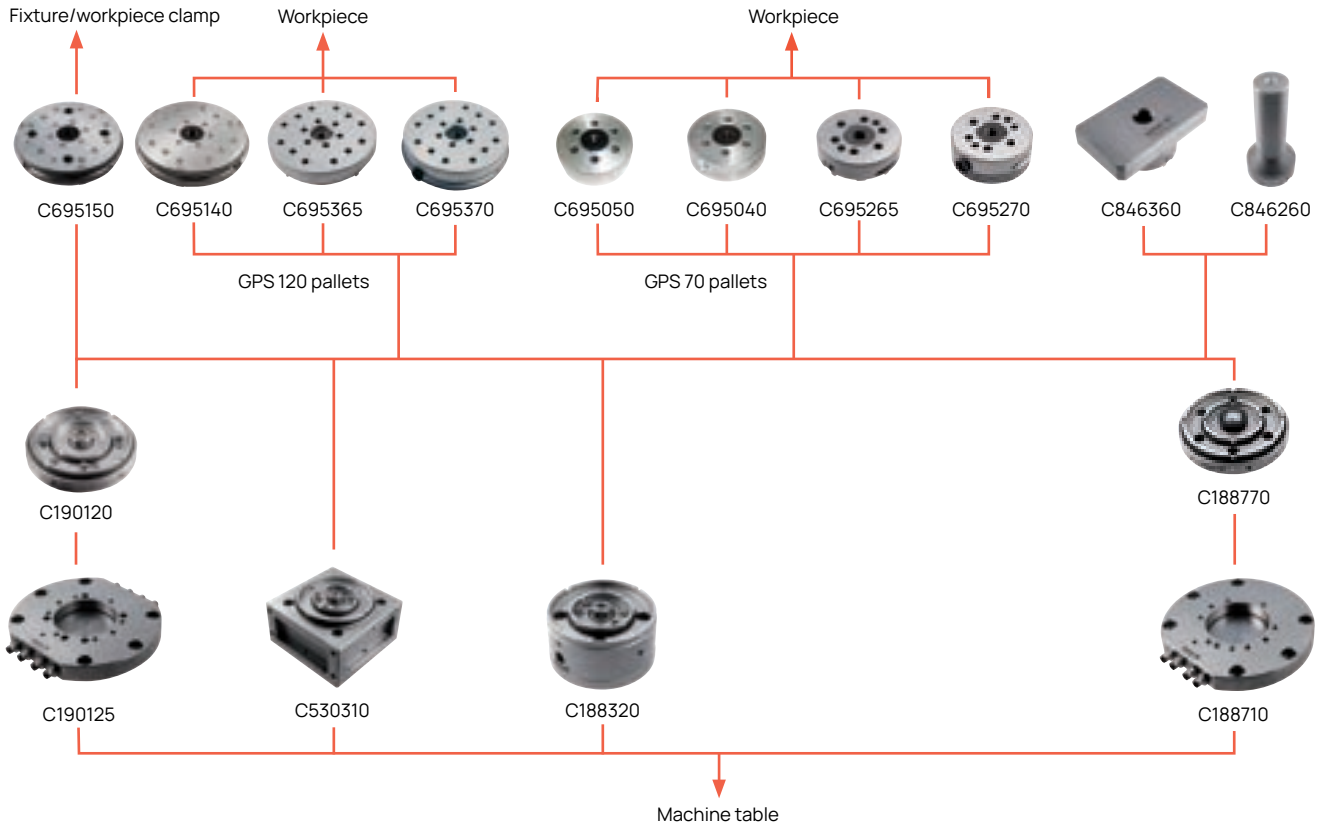

/// Pallet with coined cams    ↯ Pallet with springy hardened cams

# GPS 120 – Chucks & pallets



Chucks	Article number	Feature
Manual, cube	C530310	
Manual, round	C188320	
Pneumatic automatic/manual	C188770	for manual & automatic machining operations
Pneumatic automatic/manual	C190120	with airdock 4-fold
Flange	C188710	fits on C188700 & C188770
Flange	C190125	fits on C190120

Pallets	Article number	Feature
Cast aluminium 	C695140	
Cast aluminium 	C695150	with airdock 4-fold
Pneumatic manual (automatic) 	C695365	
Pneumatic automatic/manual 	C695370	with pallet protection ring
Pneumatic automatic/manual	C695395	fits on C695365

 Pallet with coined cams       Pallet with springy hardened cams

## GPS 120 – Chucks

### GPS 120 Machining cube, manual, C530310

For milling, grinding, die-sinking EDM, presetting and measuring station. Suitable for the 5-sided machining. One side is ground square with the base surface.

- Mounting (from the top) 12x 120 mm, 4x M8 screws threaded holes (horizontal)
- Mounting (from the bottom): on GPS 240 pallet 90 x 90 mm, 4x M8 screws through holes (horizontal), 120 x 40 mm, 4x M8 screws threaded holes (vertical)
- Releasing manual with Allen wrench.

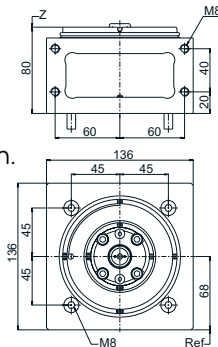
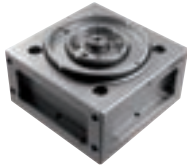

### GPS 120 Chuck, manual, C188320

For turning, milling, grinding, die-sinking EDM.

- Mounting 4x M8 screws
- Releasing manual with Allen wrench
- Flushing lateral inlet.

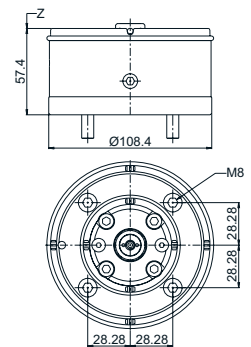

### GPS 120 Chuck, pneumatic, C188770

For automation and manual use.

- Mounting 6x M6 screws (on flange C188710)
- Releasing pneumatic, 6 bar
- Required air pressure 6 bars ( $\pm 1$ )
- Air-blast cleaning of Z-references only GPS 120.

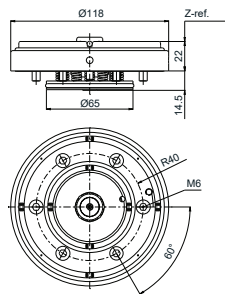

### Flange for GPS 120 chuck, C188710

Fits on C188770.

- Material stainless steel, heat pre-treated
- Mounting 6x M8
- Connections:
  - A = releasing/clamping
  - B = Air-blast cleaning of Z-references
  - C = drain/pallet room venting
  - D = piston room venting

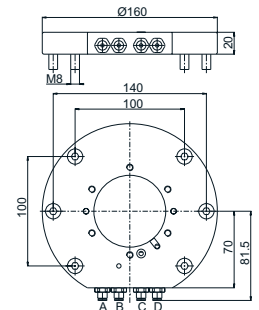
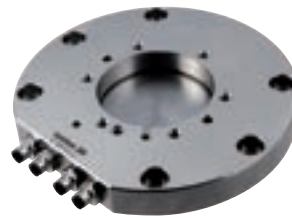

## GPS 120 – Pallets

### GPS 120 Aluminium pallet, C695140

Cast aluminium pallet.

- Construction height  $16.6 \pm 0.01$  mm
- X/Y-centring with coined cam
- Adapted for automatic changing
- Ready for code carrier fixture C960740
- Weight 0.5 kg.



#### Set of pallets, S500021

- C695140 supplied in sets of 4.

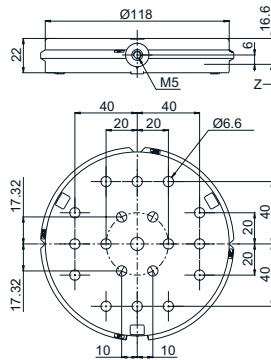

### GPS 120 Steel pallet, C695365

Workpiece and device holder for precision production.

- Construction height  $26 \pm 0.005$  mm
- X/Y-centring with springy cams, hardened, stainless
- Not for automatic changing
- Weight 1.6 kg.

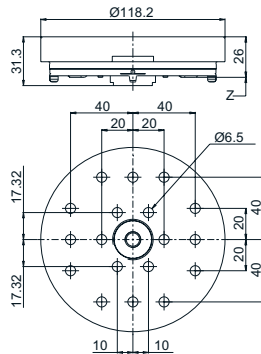

### GPS 120 Steel pallet, C695370

Workpiece and device holder for precision production with pallet protection ring aluminium.

- Construction height  $26 \pm 0.005$  mm
- X/Y-centring with springy cams, hardened, stainless
- Adapted for automatic changing
- Ready for code carrier 3R-863.01
- Weight 1.7 kg.

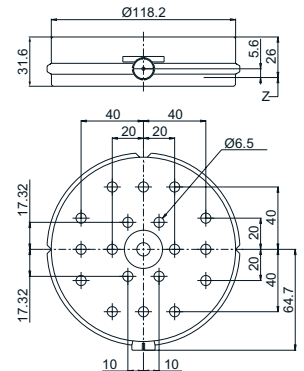

### GPS 120 Pallet protection ring, C695395

Chip protection between pallet and chuck for GPS 120 steel pallets C695365.

- Material plastic
- Dimensions  $\text{Ø}118 \times 15.7$  mm
- Not to use with code carrier.

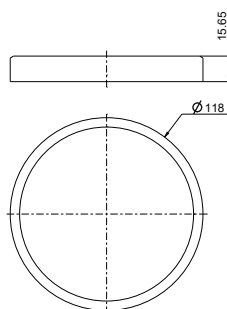

Pallet with coined cams

Pallet with springy hardened cams

## GPS 120 with airdock

The chuck with airdock is able to transfer the compressed air directly to the pallet via 4 interfaces. Fixtures and clamping elements in the automation system, amongst other things, can be operated pneumatically with the pallet C695150. The GPS 120 standard pallets can also be used on the system.



### GPS 120 Chuck, pneumatic, C190120

With airdock 4-fold.

- Stainless steel, hardened
- Mounting 6x M6 screws (on flange C190125)
- Releasing pneumatic, 6 bar
- Required air pressure 6 bar
- Air-blast cleaning of Z-references GPS 120.
- Medium connection fourfold, pneumatic 6 bar.

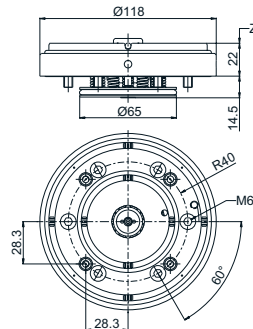

### Flange for GPS 120 chuck, C190125

With airdock 4-fold. Fits on GPS 120 chuck C190120.

- Stainless steel, heat pre-treated
- Mounting 6x M8
- Connections:
  - A = releasing/clamping
  - B = Air-blast cleaning of Z-references
  - C = drain/pallet room venting
  - D = piston room venting
  - E-G = medium connection.

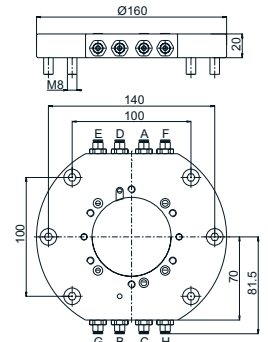

### GPS 120 Aluminium pallet, C695150

With airdock 4-fold. Fits on GPS 120 chuck C190120.

- Airdock compressed air, max. 6 bar
- Construction height 16.6 ± 0.01 mm
- X/Y-centring with coined cam
- Adapted for automatic changing
- Ready for code carrier fixture C960740.

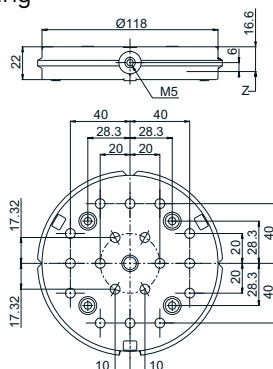

/// Pallet with coined cams

## GPS 70 & 120 – Accessories

### GPS 70 Reference pallet, C846360

For the axial and concentric XY alignment of the GPS 70/120 chuck.

- Material stainless steel, hardened
- Construction: 2-piece, form-fitting design
- Repetition accuracy of the centre bore 0.002 mm/0°
- Parallelism with system axis 0.003 mm/120 mm.
- Adapted for automatic changing
- Ready for code carrier fixture C960740.

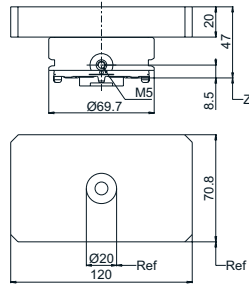

### GPS 70 Inspection plug, C846260

For the radial alignment of the GPS 70/120 chuck.

- Material stainless steel, hardened
- Construction 2-piece, form-fitting design
- Concentricity 0.005 mm/150 mm.
- Adapted for automatic changing
- Ready for code carrier fixture C960740.

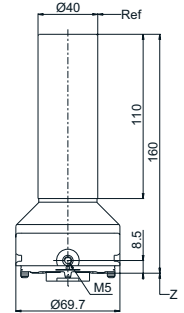

### Clamping force meter with GPS 70/120 insert, C288200 & C288230

The clamping force meter can be combined with different inserts. It will be used to check the different clamping systems, also called chucks. The unit clamped onto a chuck indicates the actual clamping force value. If the measured value is lower than the needed clamping force, a maintenance on the chuck is needed.

- Basic unit, C288200
- Insert for GPS 70/120, C288230

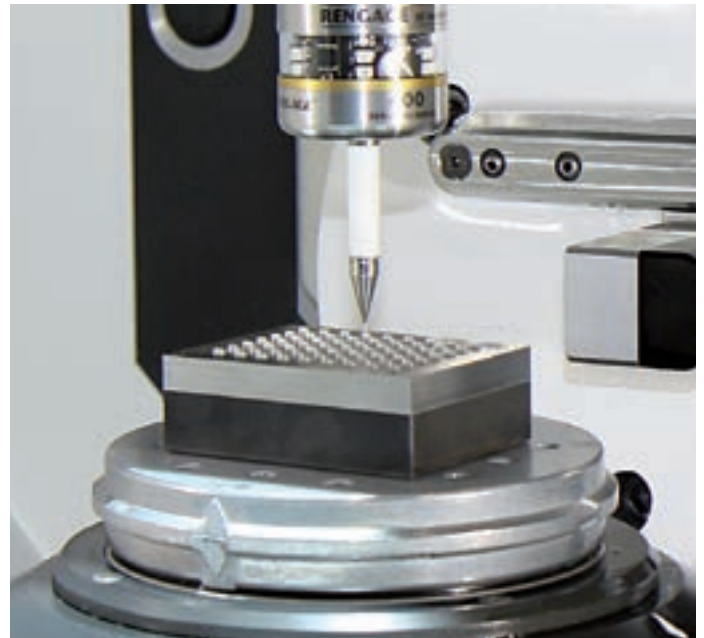

### GPS 70 Spare parts set, S230150

For GPS 70 pneumatic chucks C188720 and C198700.

- Contains all the elements for a complete service.

### GPS 120 Spare parts set, S230100

For GPS 70/120 pneumatic chucks C188700 and C188 770.

- Contains all the elements for a complete service.



### GPS 70 Spare parts set, S660000

For GPS 70 manual chucks C188300 and C530210.

- Contains all the elements for a complete service.

### GPS 120 Spare parts set, S230510

For GPS 120 manual chucks C188320 and C530310

- Contains all the elements for a complete service.



## GPS 70 & 120 – Accessories

### GPS 70/120 Pallet seal, C531000

Sealing of unused bores.

- Material elastomer
- Supplied in sets of 100.

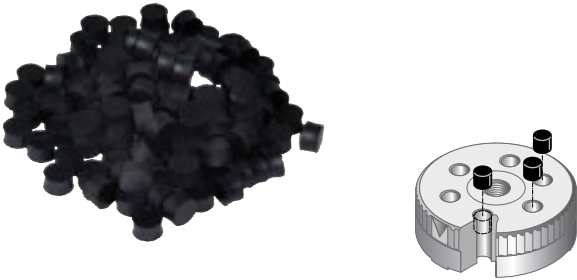

### Control unit, C960500

Manual control unit for clamping and releasing pneumatic chucks.

- Connector materials included in delivery
- Connections clamping/releasing, cleaning of Z-supports.

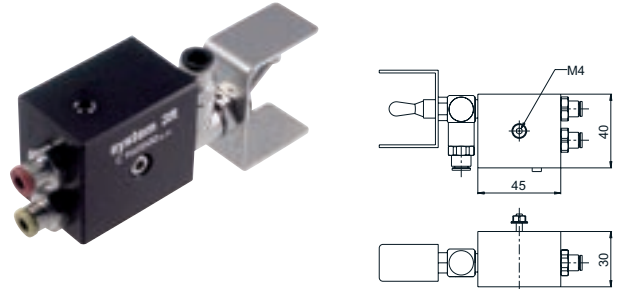

### Code carriers, 3R-863.01

With pre-programmed unique identity, designed for GPS 70/120 pallets.

#### 3R-863.01-10

- Supplied in sets of 10.



### Code carrier, fixture, C960740

Fixture for code carrier 3R-863.01-10.

- The code carrier can be clicked into position.
- Includes spacer for code carrier 2-3 mm thickness.

#### S960740

- Supplied in sets of 10.

#### S960745

- Supplied in sets of 50.

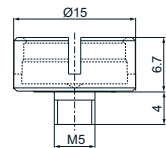

### GPS 120 Chip protection, C695176

Chip protection ring for GPS 120 chucks when used manually with GPS 70 pallets C695050.

- Material aluminium, anodized
- Dimensions Ø120 x 13.5 mm.

