

MacroMagnum in detail

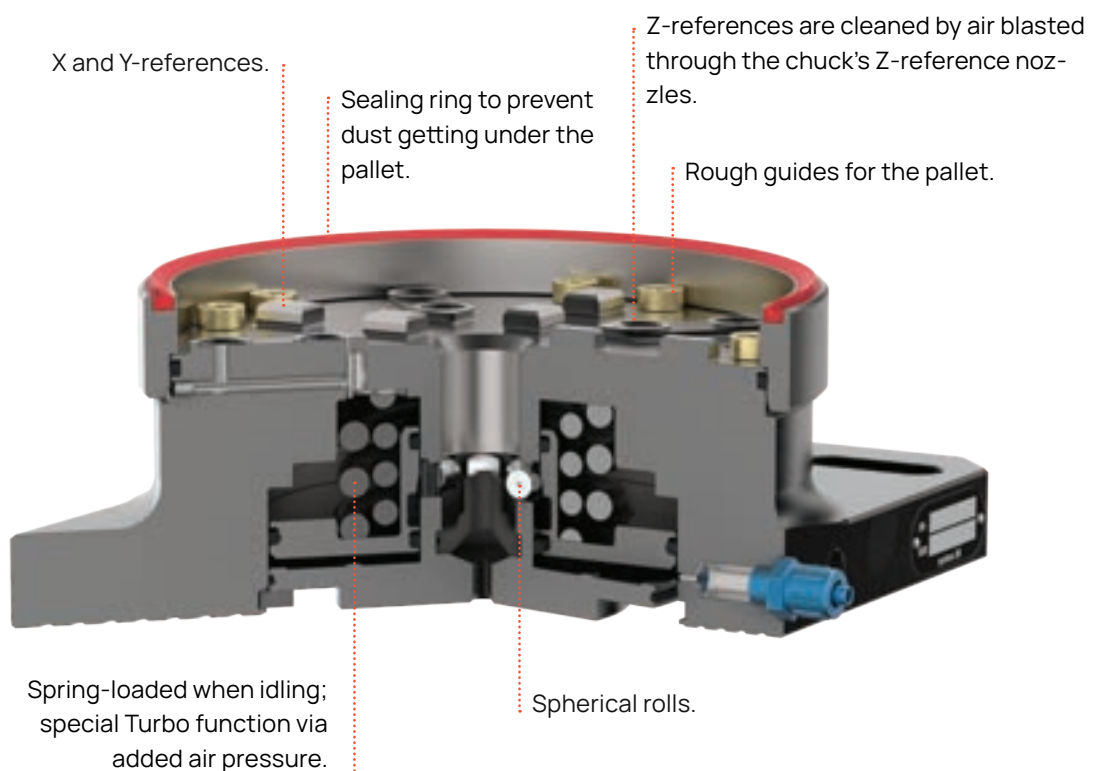

MacroMagnum – Chucks

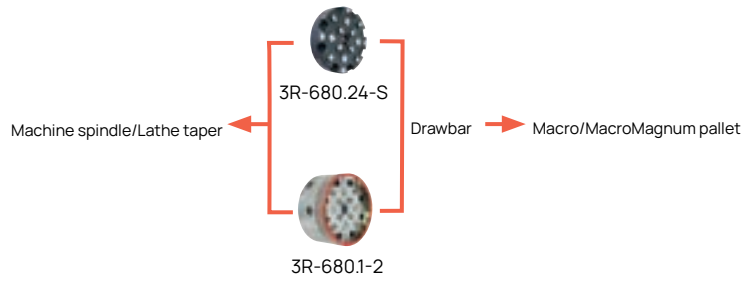
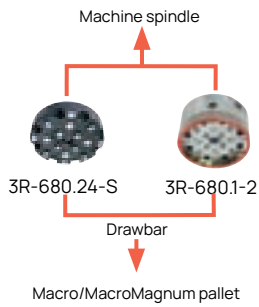

Spindle chucks	Article number	Drawbar	Feature
Manual	3R-680.24-S	3R-605.2	low profile
Pneumatic	3R-680.1-2	3R-605.1 / 3R-605.4	
Lathe chucks			
Manual	3R-680.24-S	3R-605.2	low profile, fits 90809.01-10
Pneumatic	3R-680.1-2	3R-605.1 / 3R-605.4	

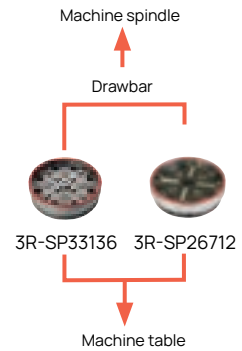
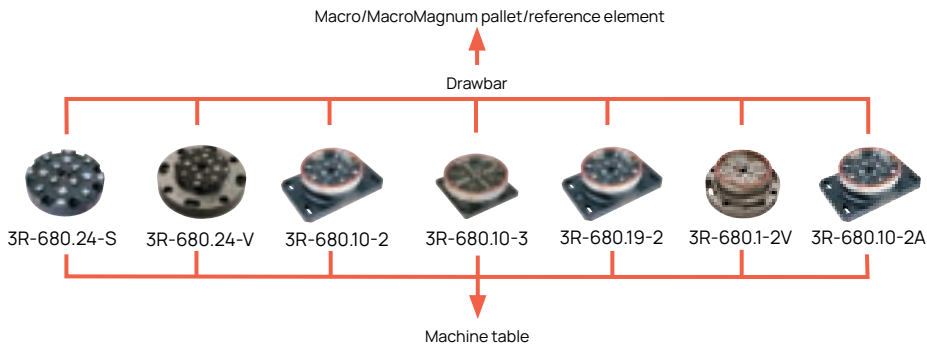

Table chucks	Article number	Drawbar	Feature
Manual	3R-680.24-S	3R-605.2	low profile
Manual	3R-680.24-V	3R-605.2	vibration-damped
Pneumatic	3R-680.10-2	3R-605.1 / 3R-605.4	
Pneumatic	3R-680.10-3	3R-605.2	low profile
Pneumatic	3R-680.19-2	3R-605.1 / 3R-605.4	3Refix Ø20 mm
Pneumatic	3R-680.1-2V	3R-605.1 / 3R-605.4	vibration-damped
Pneumatic	3R-680.10-2A	3R-605.1 / 3R-605.4	for chuck adapter
Build-in chucks			
Pneumatic	3R-SP33136	3R-605.2	low profile
Pneumatic	3R-SP26712	3R-605.2	low profile



MacroMagnum – Chucks

Manual chuck, 3R-680.24-S

Low profile chuck for permanent mounting on the machine spindle or table.

- Required drawbar 3R-605.2.
- Recommended tightening torque:
Macro pallet 4 Nm
MacroMagnum pallet 10 Nm
- Fixed index positions 4x90°
- Weight 5 kg.

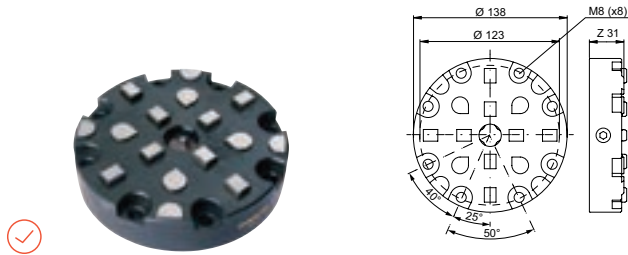

Manual chuck, VDP, 3R-680.24-V

Manual vibration-damped table chuck.

- Required drawbar 3R-605.2
- Recommended tightening torque:
Macro pallet 4 Nm
MacroMagnum pallet 10 Nm
- Fixed index positions 4x90°
- Weight 10 kg.

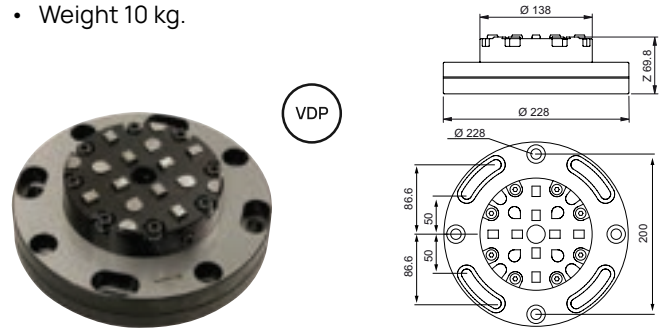

Pneumatic chuck, 3R-680.1-2

Pneumatic chuck for machine spindles and lathes. Opened/locked by an air gun against a valve on the side, or alternatively on the back, of the chuck.

- Required drawbar 3R-605.1 or 3R-605.4
- Required air pressure 6 bars (± 1)
- Fixed index positions 4x90°
- Sealing ring
- Turbo-locking of MacroMagnum pallets
- Weight 9 kg.

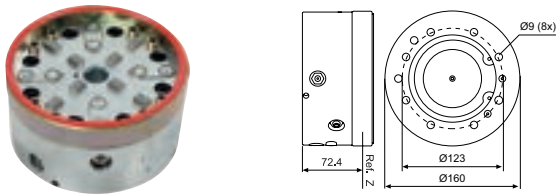

Pneumatic chuck, 3R-680.10-2

Pneumatic table chuck.

- Required drawbar 3R-605.1 or 3R-605.4
- Required air pressure 6 bars (± 1)
- Fixed index positions 4x90°
- Air-blast cleaning of the Z-references
- Sealing ring
- Turbo-locking of MacroMagnum pallets
- Weight 12 kg.

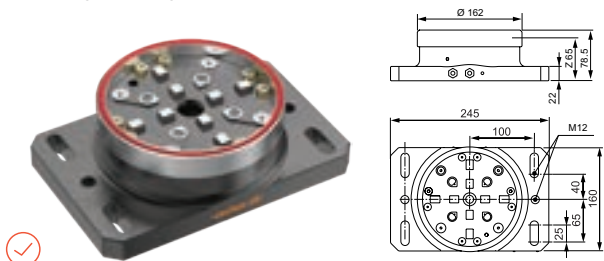

Pneumatic chuck, 3R-680.10-2A

Pneumatic table chuck for chuck adapter.

- Required drawbar 3R-605.1 or 3R-605.4
- Required air pressure 6 bars (± 1)
- Fixed index positions 4x90°
- Air-blast cleaning of Z-references on chuck and chuck adapter
- Sealing ring
- Turbo locking
- Weight 12 kg.

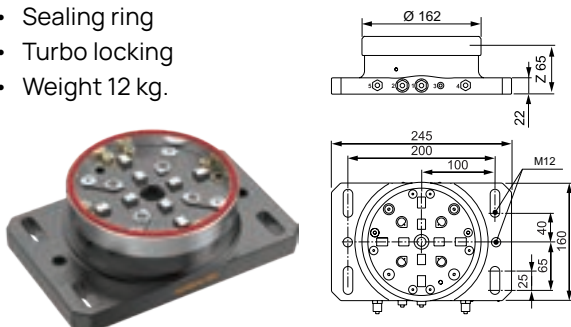

Pneumatic chuck, 3R-680.19-2

Pneumatic table chuck with 3Refix-holes.

- 3Refix Ø20 mm
- Required drawbar 3R-605.1 or 3R-605.4
- Required air pressure 6 bars (± 1)
- Fixed index positions 4x90°
- Air-blast cleaning of the Z-references
- Sealing ring
- Turbo-locking of MacroMagnum pallets
- Weight 12 kg.

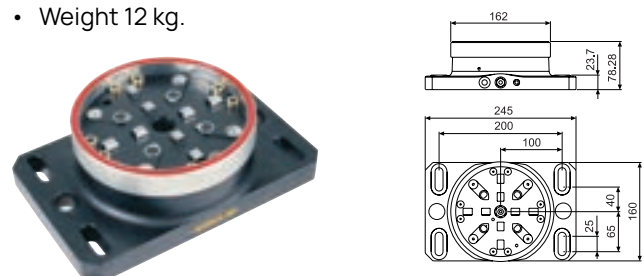

MacroMagnum – Chucks

Pneumatic chuck, VDP, 3R-680.1-2V

Pneumatic vibration-damped table chuck.

- Required drawbar 3R-605.1 or 3R-605.4
- Required air pressure 6 bars (± 1)
- Fixed index positions 4x90°
- Air-blast cleaning of the Z-references
- Turbo locking
- Weight 13 kg.

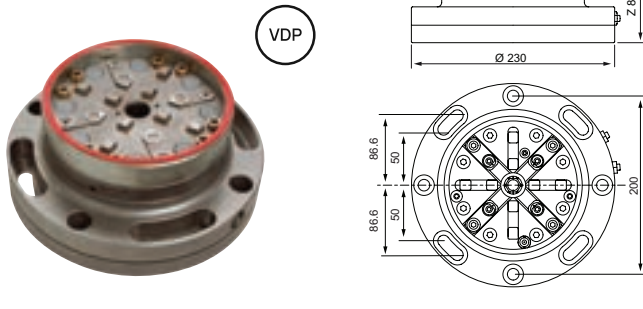

Pneumatic chuck, 3R-SP26712

For permanent mounting on the machine table.

- Supplied with drawbar 3R-605.2
- Required air pressure 6 bars (± 1)
- Fixed index positions 4x90°
- Flushing duct
- Air-blast cleaning of the Z-references
- Sealing ring
- Turbo locking
- Weight 5 kg.

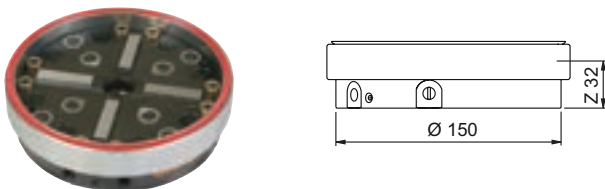

Pneumatic chuck, 3R-SP33136

Pneumatic chuck intended for permanent building-in.

- Required drawbar 3R-605.1 or 3R-605.4
- Required air pressure 6 bars (± 1)
- Fixed index positions 4x90°
- Air-blast cleaning of the Z-references
- Flushing duct
- Sealing ring
- Turbo locking
- Weight 5 kg.

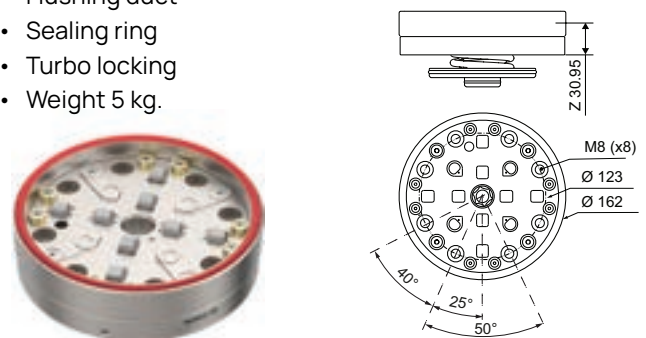

Pneumatic chuck, 3R-680.10-3

For permanent mounting on the machine table.

- Supplied with drawbar 3R-605.2
- Required air pressure 6 bars (± 1)
- Fixed index positions 4x90°
- Flushing duct
- Air-blast cleaning of the Z-references
- Sealing ring
- Turbo locking
- Weight 7.5 kg.

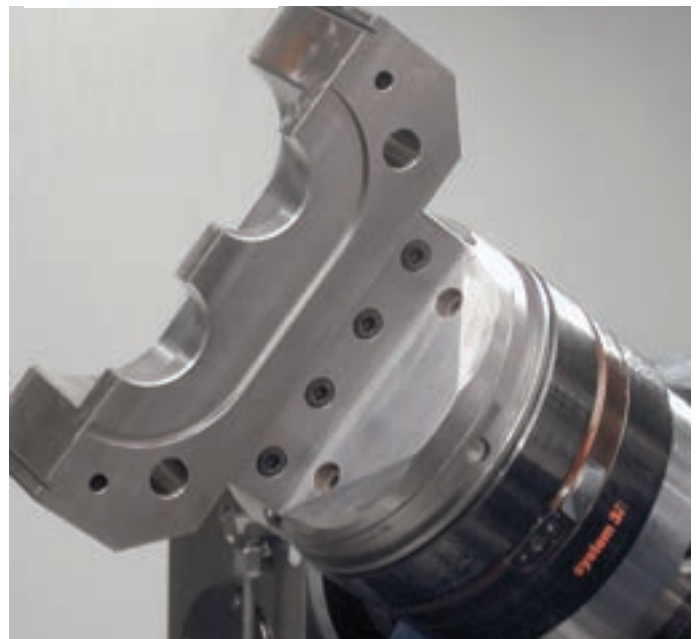
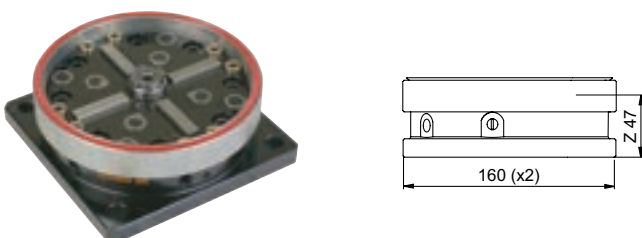

MacroMagnum – Chuck adapters

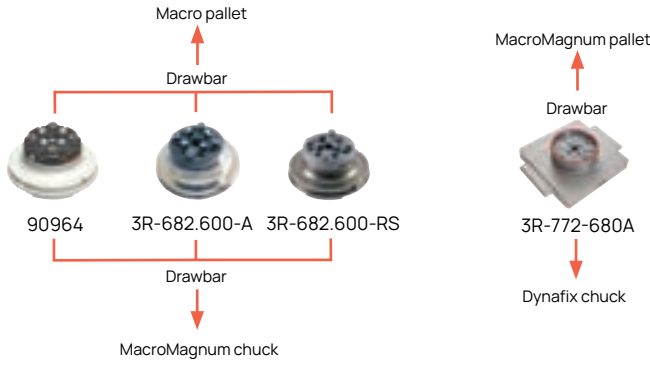

Chuck adapters	Article number	Drawbar	Feature
Pneumatic	90964	3R-605.2	MacroMagnum ► Macro
Pneumatic	3R-682.600-A	3R-605.1	MacroMagnum ► Macro
Pneumatic	3R-682.600-RS	3R-605.1RS	MacroMagnum ► Macro
Pneumatic	3R-772-680A	3R-605.1	Dynafix ► MacroMagnum

Pneumatic chuck adapter, MacroMagnum-Macro, 3R-682.600-A

Chuck adapter with built-in pneumatic Macro chuck for mounting in 3R-680.10-2A.

- Requires drawbar 3R-605.1
- Carbide X & Y-References
- Turbo locking
- Max load 50 kg to acquire accuracy 0.002 mm
- Weight 4.5 kg.

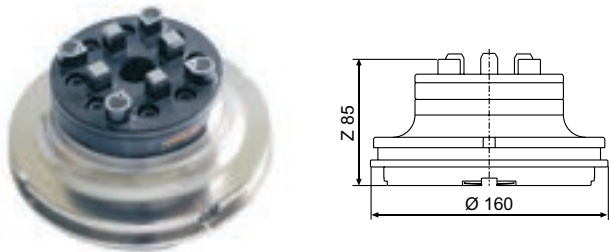

Pneumatic chuck adapter, MacroMagnum-Macro, 3R-682.600-RS

Chuck adapter with built-in Pneumatic Macro chuck.

- Requires drawbar 3R-605.1RS
- Carbide X & Y-References
- Rust resistant
- Turbo locking
- Max load 50 kg to acquire accuracy 0.002 mm
- Weight 4.8 kg.

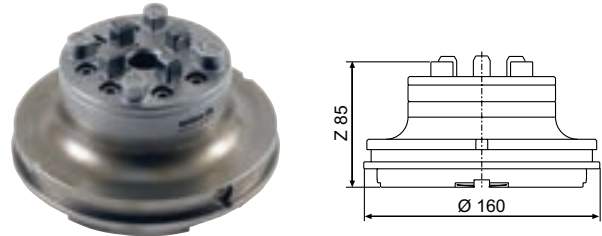

Manual chuck adapter, MacroMagnum-Macro, 90964

From MacroMagnum into Macro system. Chuck adapter with built-in Macro chuck.

- Requires drawbar 3R-605.2
- Solid X & Y-References
- Recommended clamping torque 6 Nm
- Permissible torque 135 Nm
- Max load 50 kg to acquire accuracy 0.002 mm
- Weight 4.3 kg.

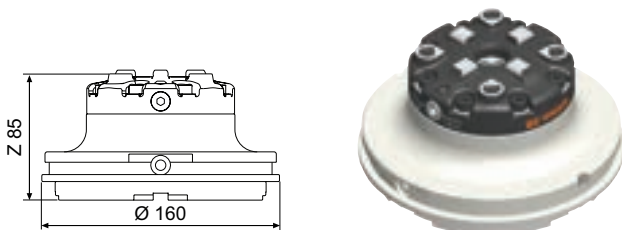

Pneumatic chuck adapter, Dynafix-MacroMagnum, 3R-772-680A

Chuck adapter with built-in pneumatic MacroMagnum chuck for mounting in 3R-770-1A or 3R-770-5A.

- Requires drawbar 3R-605.1
- Weight 13.5 kg.

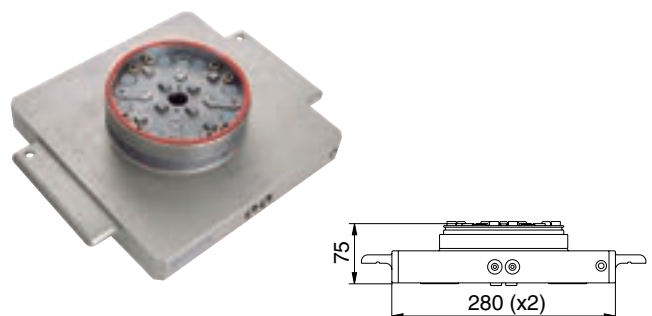

MacroMagnum – Chuck adapters

Manual Multi Station, MacroMagnum-Macro, 3R-682.600-244

Multi holder with 4 Macro chucks (prepared for 5 chucks in total). Angling clears the path for machine tools.

NOTE: Also available with 5 Macro chucks, ask for 3R-682.600-245.

- Requires drawbar 3R-605.2 (x4)
- Optimal for 5-axis machines
- Macro chucks 3R-600.24-S included (x4)
- Mounted onto a MacroMagnum pallet
- Weight 10 kg.

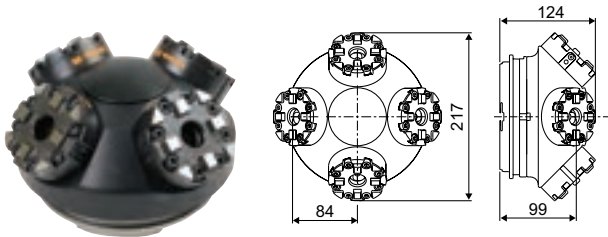

Centering vice, MacroMagnum, 3R-688-CV

Centering vice on MacroMagnum reference element. Choose between different inserts (not included).

- Vice length 160 mm
- Jaws width 60 mm
- Clamping length 49/93 mm
- Clamping force 30.000 N
- Weight 6.8 kg.

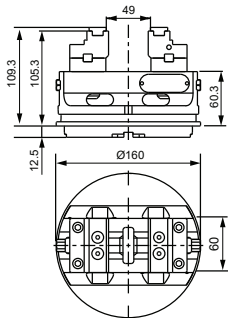

Pair of clamping inserts, MacroMagnum, 3R-688-J4

Clamping inserts 60 mm. Rough carbide coating. Fits on Centering vice, MacroMagnum, 3R-688-CV.

- Weight 0.1 kg.

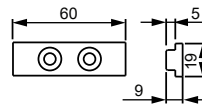

Pair of grip inserts, MacroMagnum, 3R-688-J3

Grip inserts 60 mm. Fits on Centering vice, MacroMagnum, 3R-688-CV.

- Weight 0.1 kg.

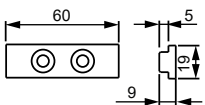

MacroMagnum – Pallets & reference element

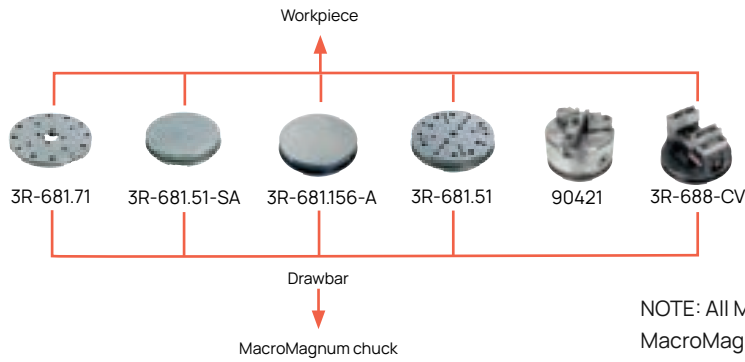

NOTE: All Macro pallets can be used in the MacroMagnum chucks.

Reference elements Ø142 mm	Article number	Feature
Hardened reference element 12.5 mm	3R-681.71	rust-resistant

Pallets Ø156 mm	Article number	Feature
Unhardened pallet 35 mm	3R-681.51-SA	
Unhardened pallet 35 mm	3R-681.156-A	reference element Ø142 mm
Hardened pallet 35 mm	3R-681.51	3Refix Ø10 mm
Three-jaw chuck	90421	

Centering vice	Article number	Feature
Centering vice on reference element	3R-688-CV	compatible with different inserts



Reference element Ø142 mm, 3R-681.71

Hardened pallet with clearance holes for fixing screws.

NOTE: Must be mounted on the workpiece/fixture before it is locked in a chuck.

- Rust-resistant
- Weight 1 kg.

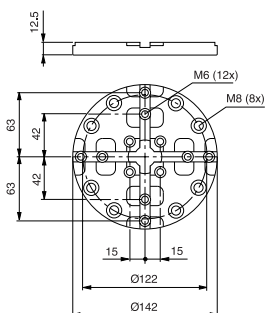

Pallet Ø156 mm, 3R-681.51-SA

Unhardened pallet with hardened references and hole markings for eight clearance holes.

- Adapted for automatic changing
- Ready for code carrier
- Weight 4.5 kg.

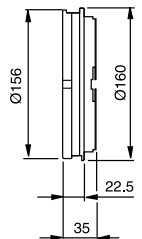
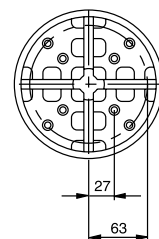

MacroMagnum – Pallets & accessories

Pallet Ø156 mm, 3R-681.156-A

Unhardened pallet with hardened reference element type 3R-681.71.

- Adapted for automatic changing
- Ready for code carrier
- Weight 4.5 kg.

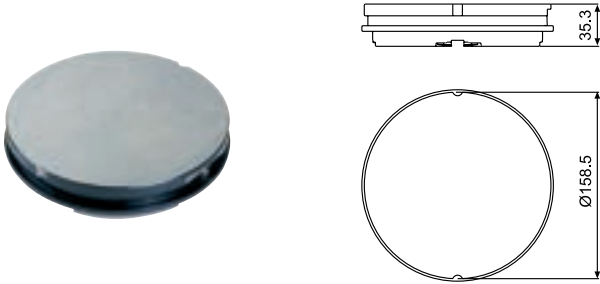

Pallet Ø156 mm, 3R-681.51

Hardened pallet with threads and clearance holes for eight and ten fixing screws.

- 3Refix Ø10 mm
- Adapted for automatic changing
- Ready for code carrier
- Rust-resistant
- Flushing connection
- Weight 5 kg.

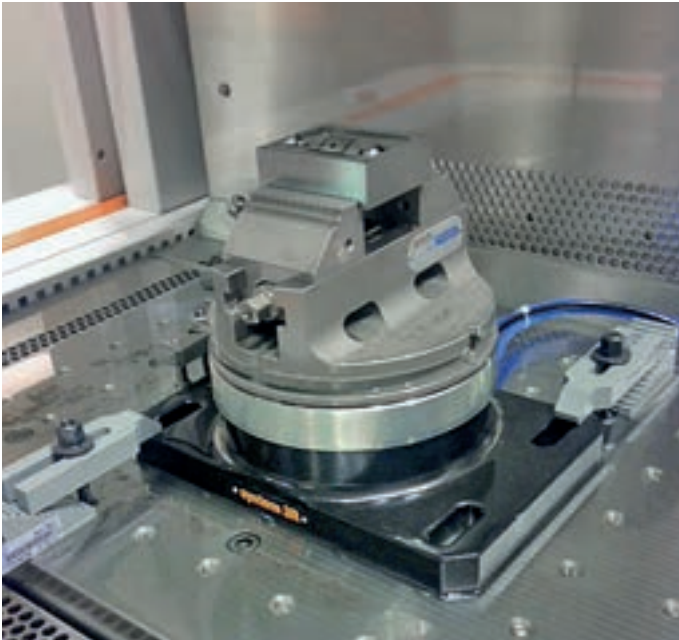
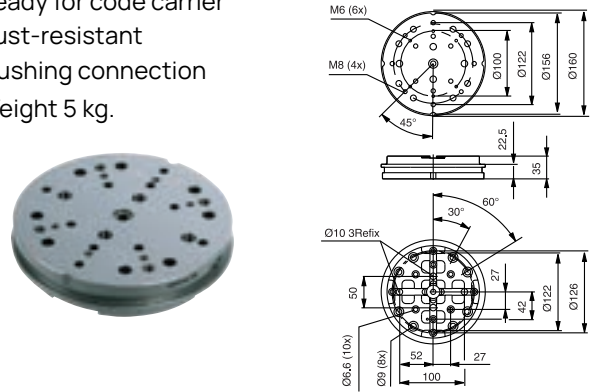

Drawbars

3R-605.1E

- Ø20x57.1 mm with flushing holes Ø7 mm
- Supplied in sets of 10.



3R-605.1EE

- Supplied in sets of 40.



3R-605.2

Ø20x36.9 mm with Ø7 mm flushing hole



3R-605.2E

- Supplied in sets of 5.



3R-605.2EE

- Supplied in sets of 20.



3R-605.4E

For round pallets adapted for automatic changing.

- Ø20x57.1 without flushing hole
- Supplied in sets of 10.

3R-605.4EE

- Supplied in sets of 40.



MacroMagnum – User kit & Accessories

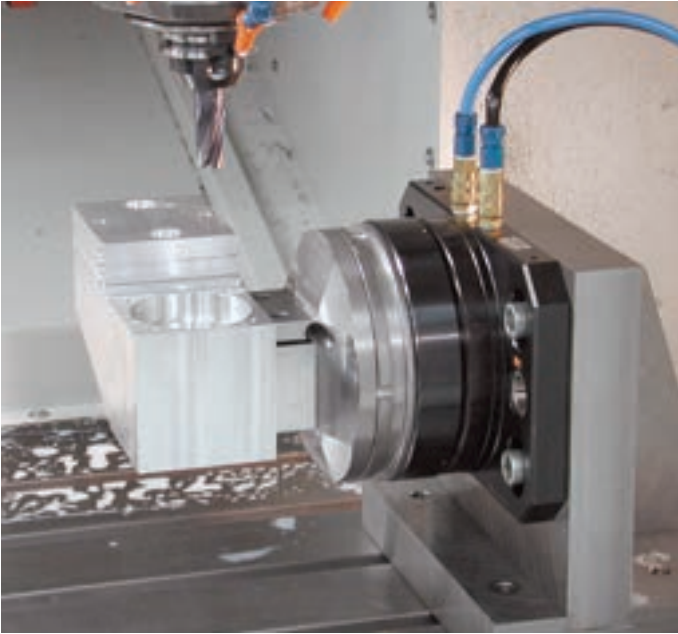

Three-jaw chuck, 90421

Three-jaw chuck mounted on pallet 3R-681.51-SA.

- Adapted for automatic changing
- Ready for code carrier
- Total height 127 mm
- Weight 16 kg.



Control ruler, 3R-686.1-HD

Control ruler for setting flatness and angular positions. Ground hole for centring.

- Adapted for automatic changing
- Ready for code carrier
- Measuring length 130 mm
- Weight 6 kg.



Splash guard, 90027.03

Intended for MacroMagnum chucks. Can also be used as a cover for unused chucks.



User kit, 3R-688.24-S

3R-680.24-S, MacroMagnum chuck, Manual, Low profile, 1 pc.

3R-681.51-SA, MacroMagnum Pallet Ø156 mm, 4 pcs.

3R-605.2, Drawbar, 2 pcs.



3Refix mandrel, 3R-901-10E-TX

- 3Refix Ø10 mm
- Recommended tightening torque 4 Nm
- Supplied in sets of 10
- Weight per set 0.2 kg.

NOTE: When positioning with 3Refix mandrels – always tighten the expanding mandrel in the R0 hole first.



MacroMagnum – Accessories

Control unit, 3R-611.2

Foot operation of pneumatic chucks.

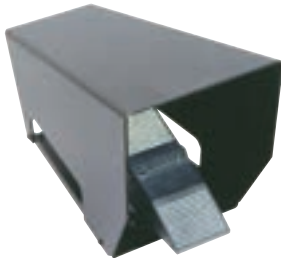

Control unit, 3R-611.4

Unit for operation of pneumatic chucks. Two functions, opened/ closed.



Control unit, 3R-611.46

Unit for hand operation of pneumatic chucks. Three functions – open/neutral/closed.

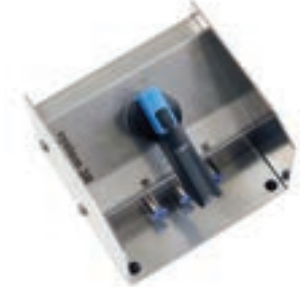

Torque wrench, 3R-614-04

For Ø10 mm 3Refix mandrels and manual MacroMagnum chucks.

- 4 Nm.



Code carriers, 3R-863.01-10

With pre-programmed unique identity, designed for pallet use.

- Supplied in sets of 10.



Connection for air gun, 90815

For manual operation of pneumatic chucks with air gun.

- Supplied in sets of 2.



Clamping force meter kit, 3R-SSP115-BASE

For both pneumatic and manual chucks. This stand alone unit in combination with individual drawbars or drawbar kits, able to cover MacroJunior, Macro, MacroMagnum and Dynafix.

NOTE: Require drawbars with bayonet interface similar to 3R-605.1.

- Add-on kit for use in Macro/MacroMagnum, 3R-SSP115-Macro
- Operating temp. +10 to +40° C
- Gauge size Ø90x47 mm
- Working range 1-22 kN
- Deviation ± 0.1 kN.
- Weight:
Display 0.34 kg.
Gauge 1.3 kg.



Add-on kit, 3R-SSP115-Macro

Add-on kit for 3R-SSP115-BASE.

